



SHOPFITTING AND STORE EQUIPMENT

FOCUS **SHOP**

Solutions for pluggable electrical installations
in shopfitting.



“The number of electrical consumers in retail spaces is steadily increasing. Our pluggable and flexible installation systems are helping to meet these requirements.”

FRANK KOBERSTEIN

Local Key Account Manager Retail & Investors

HELLO SHOP

- 04** Introduction to pluggable decentralized store cabling
- 06** Advantages for your areas of application
- 08** Solutions for infrastructure cabling
- 10** Solutions for electrical retailers / DIY stores
- 12** Solutions for supply to the point of sale
- 14** Solutions for media shelves and tables
- 16** Solutions for supply to shelving
- 18** Solutions for 1/3 lighting
- 20** Solutions for dimmable lighting
- 22** From conception to rollout
- 24** Standards and the Construction Products Regulation
- 26** Services and servicing packages, gesis® PLAN
- 27** General information + contacts



OUR ANSWER TO DIGITIZATION AND LED ACCENTUATION IN STORES.

As an experienced and reliable partner, we can help you satisfy your shopfitting requirements with safety, efficiency, and pluggability. For over 40 years, we have been offering smart solutions with our pluggable connector systems for the lighting and the infrastructure all the way to the shelf socket.

Customer service systems, digital shelf systems, and accent lighting are becoming standard features, and require in stores and at the POS suitable technical infrastructure. To this end we offer the best possible installation solutions and energy-efficient automation components. Due to the high degree of prefabrication of the pluggable electrical installation and the simple on-site assembly, short assembly times and a clean construction process are possible. With gesis® we guarantee a smooth, timely, and stress-free rollout for your retail spaces.

THE SYSTEM FOR:

- + FURNISHING STORES
- + LARGE-SCALE SPECIALIST STORES
- + CLOTHING AND SPORTS STORES
- + NON-FOOD SHOPS
- + SHOP-IN-SHOP SYSTEM
- + INTERNATIONAL ROLLOUTS
- + SUPERMARKETS



ECONOMICAL PLANNING CAPABILITY

gesis® ensures that project flows can be calculated and guarantees standardized quality in planning and execution.



RELIABLE PROCESS QUALITY

gesis® ensures a stable high execution quality of the building installation and automation due to the possible industrial prefabrication.



QUICKER ASSEMBLY

Pluggable technology, pre-fabricated cable sets, and a variety of connection technology significantly reduce installation times.

SMART **ADVANTAGES** FOR YOUR AREAS OF APPLICATION.

Our system components offer additional advantages, enabling you to win major projects and impress your customers:



SAFE & SECURE INSTALLATION

Our gesis® and RST® components feature an locking device to secure them against unintentional loosening. This ensures a fixed installation as specified in IEC 61535 and thus a certified quality & safety according to international standards. The color and mechanical coding further guarantees safety by preventing the mismatching of different voltage connectors.



DIGITIZATION

Bricks-and-mortar stores are offering more digital services than ever before. Our solutions enable the integration of smart shelves with electronic shelf labeling (ESL) in the store infrastructure. Shelf lighting can be connected at the same time.



SUSTAINABLE + FUTURE-PROOF

Our long-standing experience as a market leader and our product quality ensure high contact reliability, a long service life, and high component availability. With our simple and pluggable installation you are optimally prepared for future modifications and extensions. In addition, our components comply with with stringent environmental standards for manufacture and reusability to help you achieve your environmental objectives.

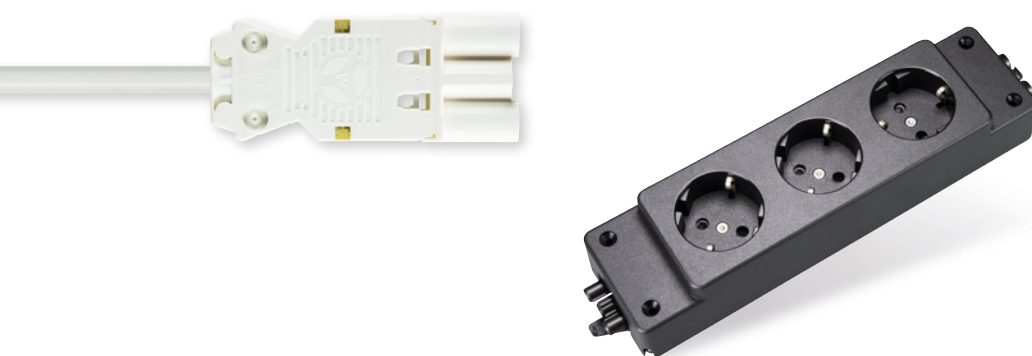



STRUCTURED

The combination of multi-phase flat cables with flexible outputs, pre-assembled connecting cables, and distribution blocks produces a clear and simple structure with a limited list of components. This ensures efficient maintenance and flexible extension capability, entirely without the use of skilled labor.



MODULAR & VERSATILE

Through our standardized gesis® interface we offer a modular system for all electrical connections. Whether the focus is on lighting, supplying consumers, connecting promotional and demo equipment, mains voltage, three-phase current, or data – with gesis® and RST® you will always be using the right products.



SAFE

The color and mechanical coding of every system prevents mismatching during the initial installation and during any changes and extensions. All unused connections are touch-proof in principle and can also be closed with covers.

APPLICATION FIELDS IN WHICH OUR PRODUCTS AND SOLUTIONS ARE USED:



Media shelves



Energy + data supply to the point of sale



Smart shelf



LED light boxes and frames



Refrigeration electrification



Lighting, Tunable White, DALI, KNX, emergency lighting

CONTINUOUS PLUGGABLE INFRASTRUCTURE CABLING

REFRIGERATED SHELF

REFRIGERATION SUPPLY

REFRIGERATION LIGHTING

PLUGGABLE
SHOP LIGHTING



FLEXIBLE BUSBAR

The flat cable serves as the busbar for flexible energy provision in any position inside the retail space. It is laid ideally along the walls, but inside ceilings or floors is also an option.

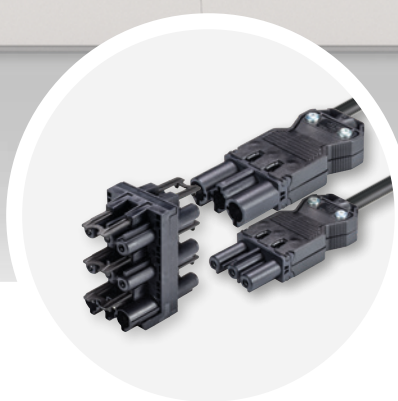

PLUG & PLAY IN THE STORE

Seasonal constructions, decoration, or secondary placements can be supplied with electricity and realized in any position easily, quickly, and without any installation work.



WIELAND PREFAB® UI

Interface between the pluggable electrical installation and the consumer, for use in modular walls. Pre-assembled and pluggable, they are ideal for quick, easy, and error-free installation in the factory and during commissioning on site.



APPLICATION

With store concepts changing all the time, it is essential to be able to respond quickly. Refrigerators, refrigerated counters, and light displays are generally supplied from the wall or ceiling and then require an adjustment of the electrical connection points.



SOLUTIONS

- Industrially prefabricated system components
- gis® NRG flat cable with 3-pole, pluggable adapters with phase selection
- gis® CLASSIC cabling to the consumers



ADVANTAGES

- Fast, easy, and safe installation
- High functional reliability through prevention of mismatching
- Simple adjustment of the installation to local conditions
- Subsequent extensions made easy thanks to pluggable components



EASY **PLUG & PLAY** SOLUTIONS FOR ELECTRICAL RETAILERS/DIY STORES.

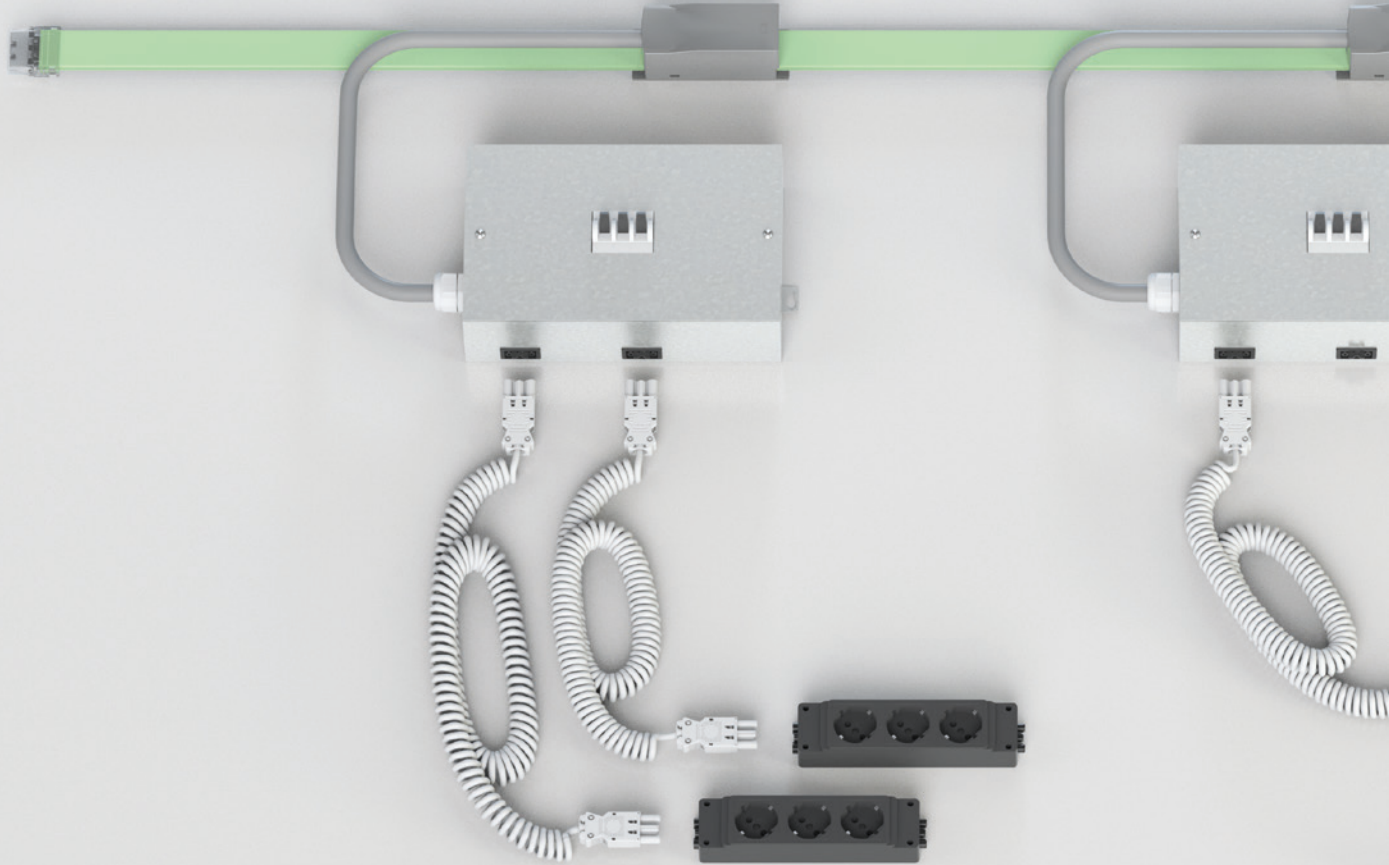

INFRASTRUCTURE CABLING

The retail space is supplied via flexible 5G10 mm² flat cables. This markedly reduces the cabling required and provides unlimited energy within the area.

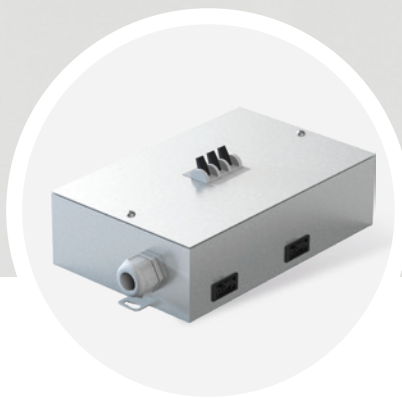

SYSTEM DISTRIBUTORS

Our system distributors secure energy supply with locally fused gesis® outputs. New load centers can be created by additional system distributors at any time.



DEVICE SOCKETS

Our sockets with gesis® connection are simply pluggable and secure energy supply to end devices. They are also available with optional fine surge protection.



APPLICATION

In electrical retail outlets and DIY stores, larger electrical loads are required in a variety of ever-changing areas, such as shelves, sections, and recesses.

Sockets also have to be made available flexibly.



SOLUTIONS

- Industrially prefabricated system components
- Prefabricated gesis® system distributors with connection cable and flat cable adapter
- Local fuse protection and pluggable outputs to the shelves
- Energy distribution as per IEC 61535 as part of the fixed installation



ADVANTAGES

- Fast, easy, and safe installation
- High functional reliability due to defined, symmetrical structures
- Easy adjustment to change load centers
- Modifications at the socket level can be done by electrically trained staff



- + Chaining of gesis® multiple sockets possible
- + Power taps can be placed in any position
- + Modular installation



SMART **PLUG & PLAY** SOLUTIONS FOR **SUPPLY TO THE POINT OF SALE.**

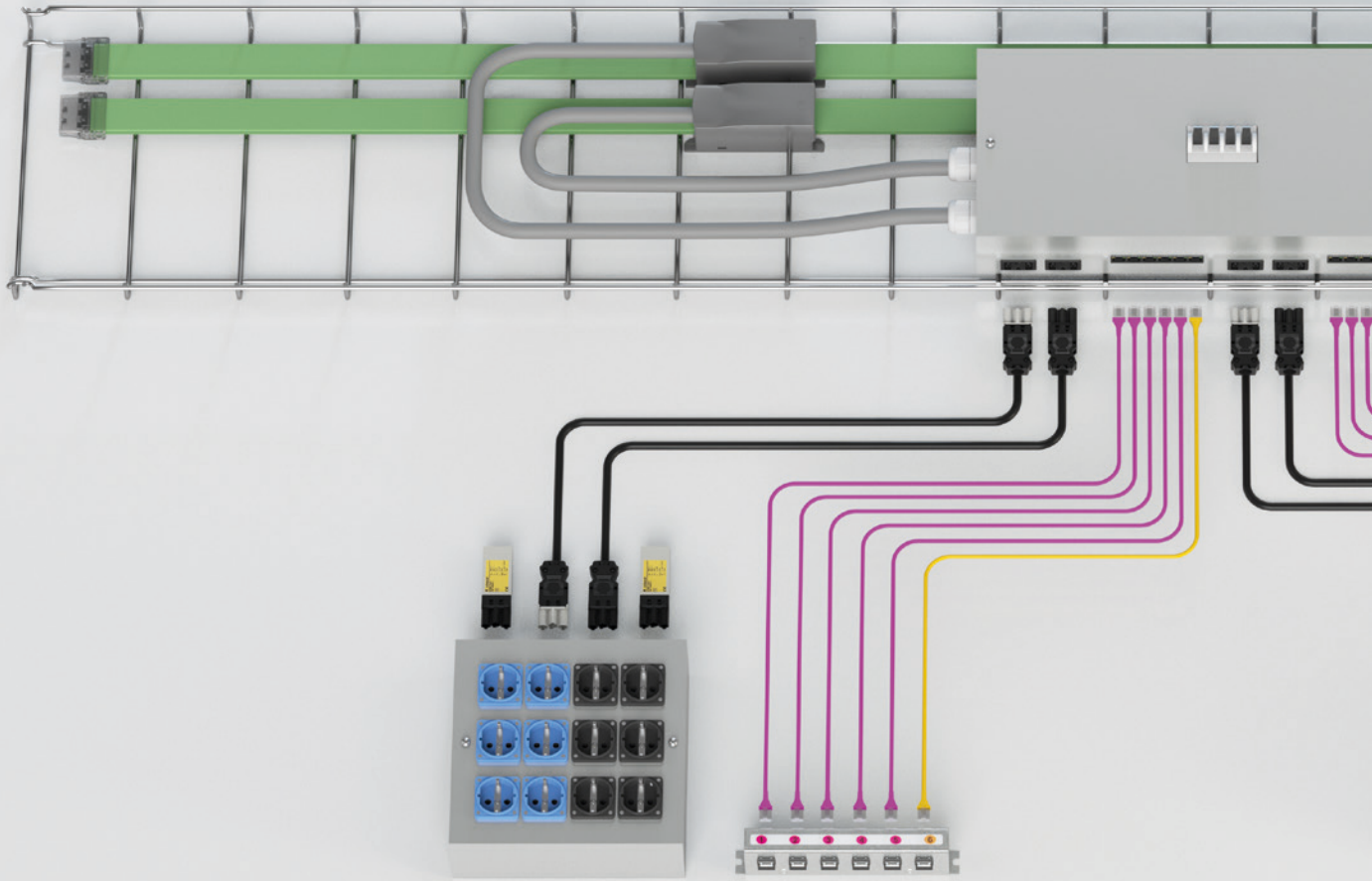

INFRASTRUCTURE CABLING

The checkout areas are supplied via our flexible 5G10 mm² flat cables with two networks (AV and SV). This greatly reduces the cabling required.

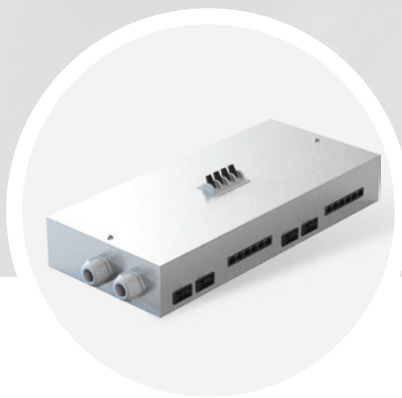

SYSTEM DISTRIBUTORS

Our system distributors are equipped with fused pluggable gesis® outputs. They are responsible for the decentral protection and simultaneously connect the IT systems to each other via RJ45.



SOCKET DISTRIBUTORS

Our sockets can also be connected in a pluggable manner and offer maximum flexibility and order in the supply to all consumers at the checkout.



APPLICATION

The gesis® system distributor on the cable route is supplied with AV and SV network. There are 12 data cables laid in the IT part. The connection from the ceiling to the twin checkout desk is carried out using gesis® CLASSIC connection cables and patch cables. One system distributor with sockets and one with 6 x RJ45 data connections is installed in each checkout.



SOLUTION

Industrially prefabricated system components gesis®

- NRG flat cable system for energy supply
- Distribution box for modular pluggable decentralized energy distribution and fuse protection
- Pluggable installation system for long maintenance intervals via gesis® supplied pluggable sockets for simple power supply within the checkout area
- Optional positioning of a switch in the checkout desk



ADVANTAGES

- Fast, easy, and safe installation
- High functional reliability due to clear structures
- Simple adjustment of the installation to local conditions
- Subsequent extensions made easy thanks to pluggable components

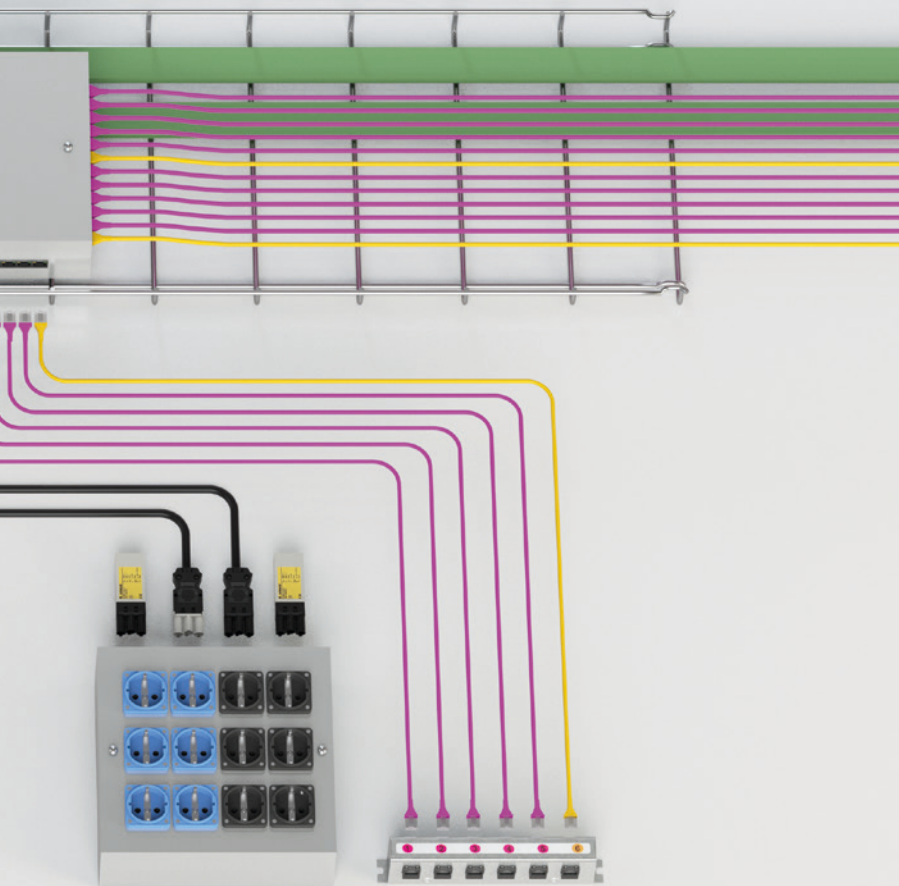

- + Modular installation
- + Fine surge protection
- + Simple structure at the checkout counter



EFFICIENT **PLUG & PLAY** SOLUTIONS FOR **ENERGY DISTRIBUTION** IN **MEDIA SHELVES AND TABLES.**



DEVICE SOCKETS

Our safety sockets with gesis® connection secure energy supply to consumers and can also be extended to include fine surge protection as an option.





APPLICATION

In electrical retail outlets, media tables and shelves are used to present and demonstrate various small electrical appliances. These are usually supplied via linked multiple sockets. Besides appearing chaotic and unattractive, this kind of cabling is not permissible. The electrical protection devices could be disturbed in their function, which could lead to increased safety risks or even fire.



SOLUTIONS

- Industrially prefabricated system components
- gesis® pluggable multiple sockets for easy and safe energy supply with a connection level as per IEC 61535
- Pluggable fine surge protection to protect the connected appliances



ADVANTAGES

- Fast, easy, and safe installation
- High functional reliability through prevention of mismatching
- Simple adjustment of the installation to local conditions
- Subsequent extensions made easy thanks to pluggable components

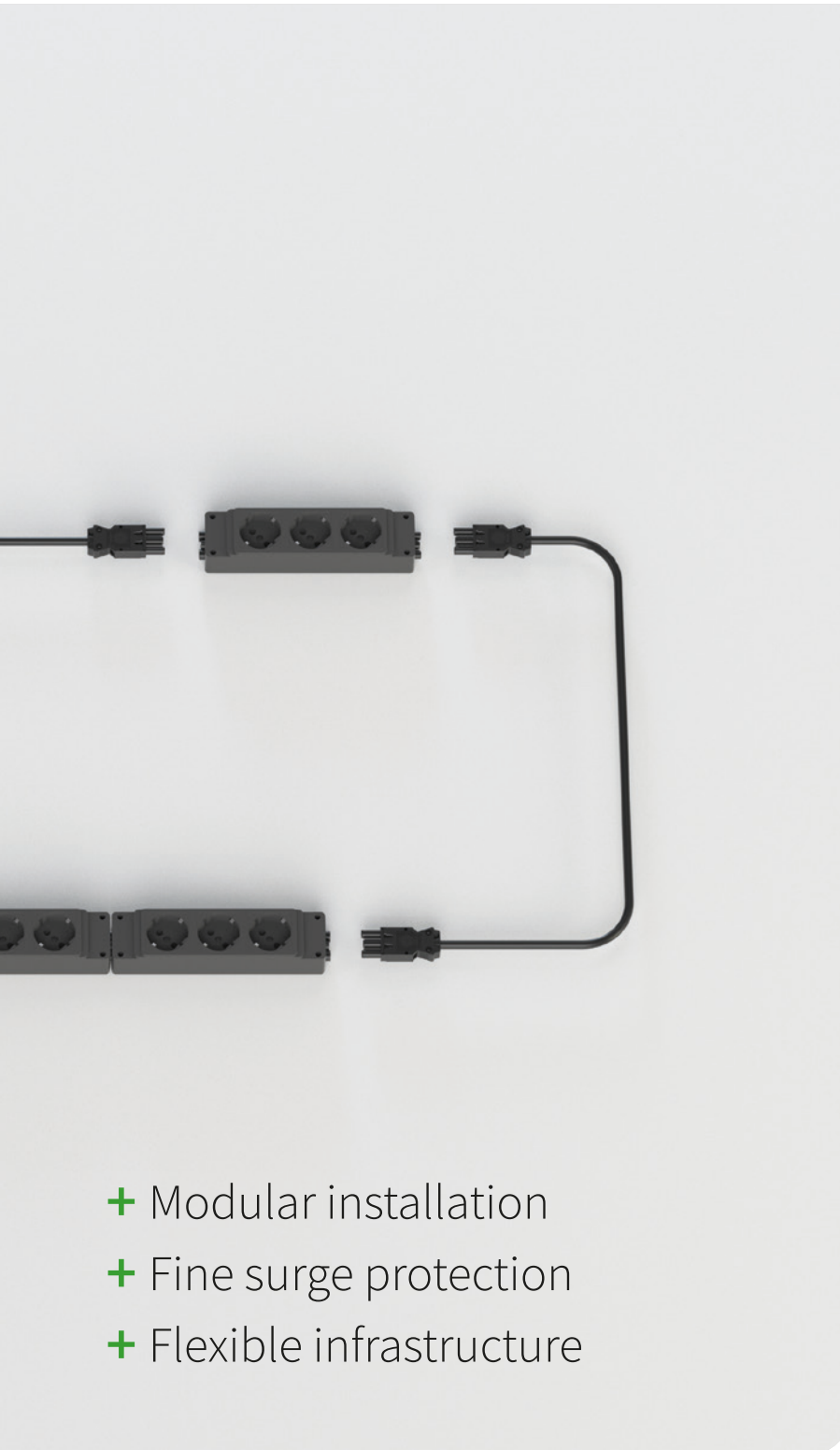

- + Modular installation
- + Fine surge protection
- + Flexible infrastructure



FLEXIBLE **PLUG & PLAY** SOLUTIONS FOR **SUPPLY TO SHELVING.**

SHELF LEVEL 1

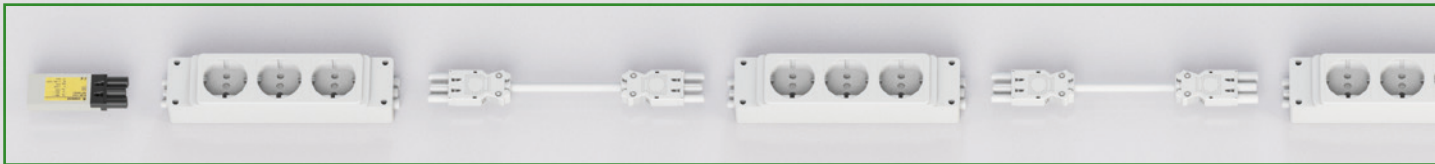

SHELF LEVEL 2



PLUGGABLE SUB-DISTRIBUTION

Our completely pluggable distributors can be wall-mounted and are equipped with the necessary electrical protection devices.



PLUGGABLE JUNCTION BOX

The supply is allocated to various shelves or shelf levels, for example, using a pluggable junction box without any effort.



PLUGGABLE SURGE PROTECTION

Our local overvoltage protection is simply plugged in and provides all connected devices with reliable protection against a power surge.



APPLICATION

The devices on the store shelves have to be supplied with energy so that they can be displayed while operational. In the event of a localized fault, only small areas should lose power.



SOLUTIONS

- Industrially prefabricated system components
- Decentralized fuse protection in the space with gesis® WIV distributor for local protection
- gesis® CLASSIC installation plug connector system as per IEC 61535 for supply to the distributed multiple sockets



ADVANTAGES

- Fast, easy, and safe installation
- High functional reliability through prevention of mismatching
- Simple adjustment of the installation to local conditions
- Subsequent extensions made easy thanks to pluggable components

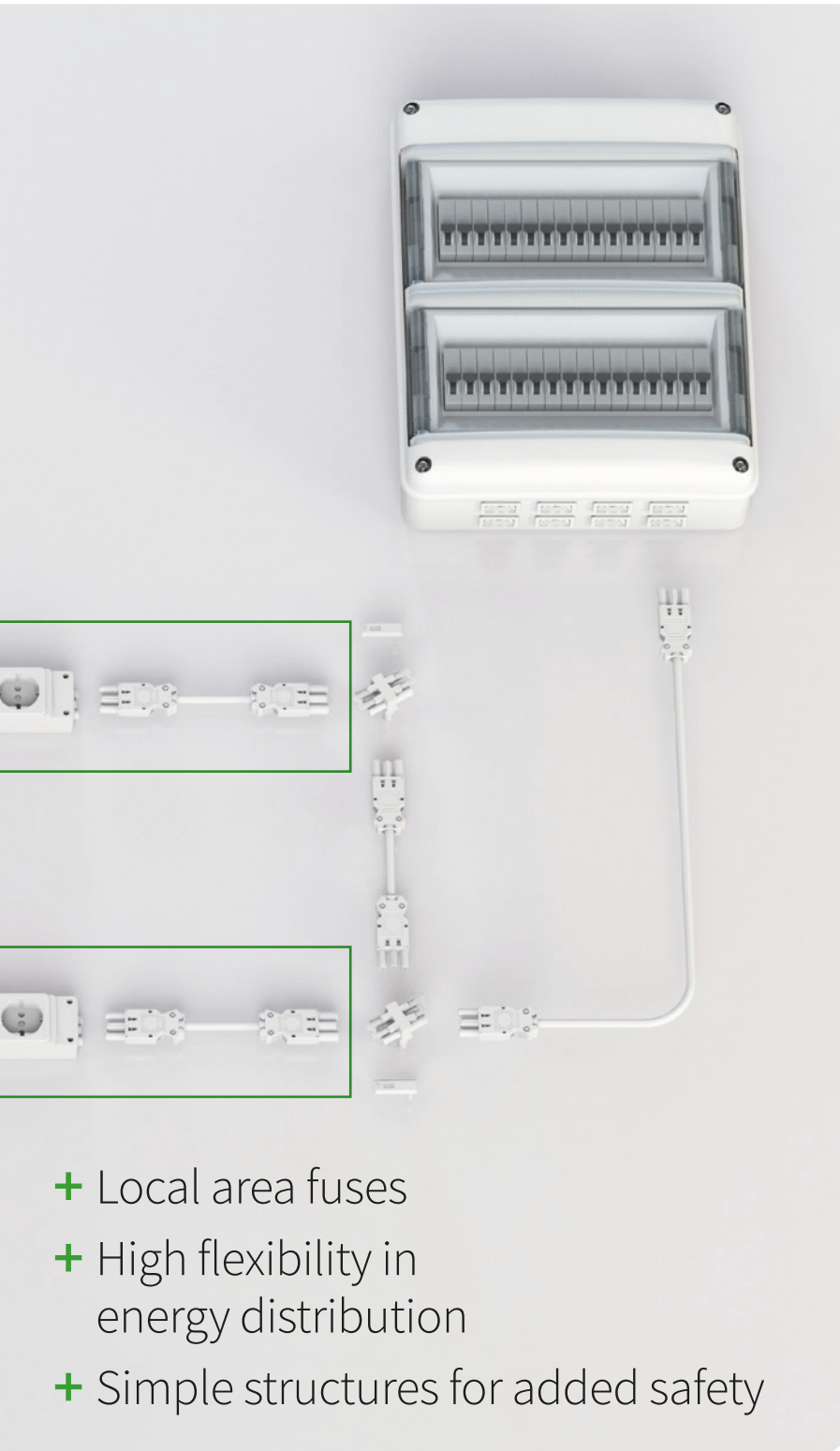

- + Local area fuses
- + High flexibility in energy distribution
- + Simple structures for added safety





EASY **PLUG & PLAY** SOLUTIONS FOR **1/3 LIGHTING.**

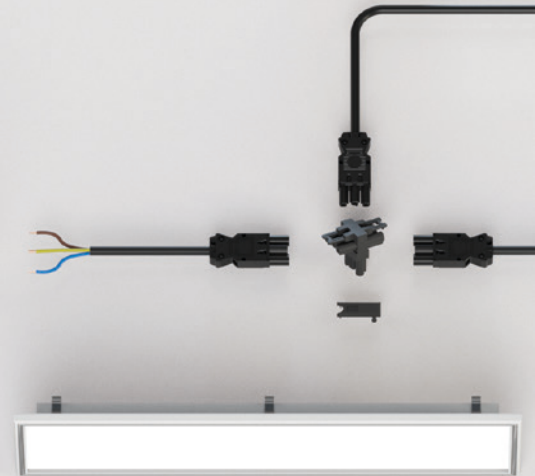

ENERGY SUPPLY

Power taps can be placed anywhere along the flat cable. Prior to establishing contact with piercing screws the phase selection is made. Subsequent changes are possible without the need to move the tap.

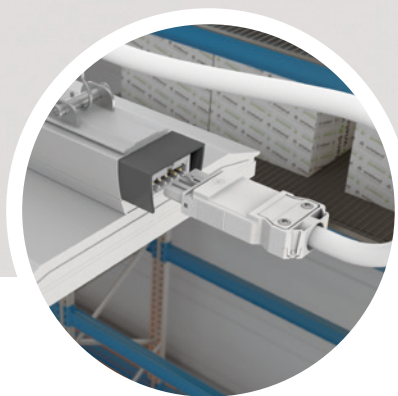

LUMINAIRE CONNECTION

The installation system offers suitable pluggable connections for various types of luminaires. Color and mechanical codings prevent mismatching.

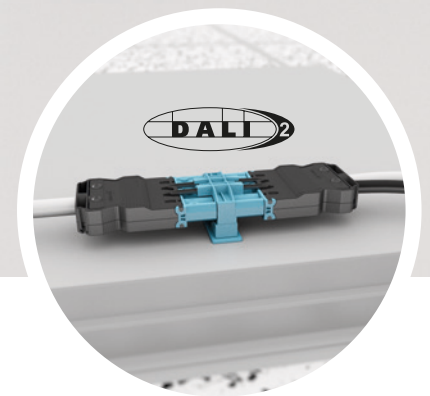

DIMMING APPLICATIONS

Luminaires can be supplied with energy via flat cable using a direct and pluggable approach. For dimming applications, pastel blue connectors are available.



- + Easy group assignment of luminaires via phase selection on the flat cable adapter
- + Flexible luminaire positioning



APPLICATION

The easiest way to power retail spaces is with the established 1/3 circuit. The group assignment with 5-pole cabling systems can be determined by the choice of phase. Lighting is made switchable for nights and cleaning times, providing flexibility and efficiency.



SOLUTIONS

- Industrially prefabricated system components
- gesis® NRG flat cable system for easy placement and removal of pluggable outputs
- 3-pole, pluggable flat cable outputs with phase selection for simple and flexible luminaire group assignment



ADVANTAGES

- Fast, easy, and safe installation
- High functional reliability through prevention of mismatching
- Simple adjustment of the luminaire groups to local conditions
- Subsequent extensions made easy thanks to pluggable components



EASY **PLUG & PLAY** SOLUTIONS FOR DIMMABLE **LIGHTING**.



INDOOR SOLUTION

The indoor version of the system can be executed flexibly with round cables and/or flat cables. Changes and extensions are part of the installation concept right from the outset.

DISTRIBUTION OPTIONS

Adjustment and extension of the lighting is made extremely easy with our pluggable distributors – no relevant installation work required.

LUMINAIRE CONNECTION

The luminaires no longer have to be opened during on-site installation thanks to the pluggable device connection or pre-assembled connection cable; they are immediately ready to use.



APPLICATION

Our 7-pole infrastructure cabling with dimming signal and three-phase current is particularly popular for minimizing the voltage drop in systems that span great distances. With its elevated ingress protection code, it is also ideal for harsh environments.



SOLUTIONS

- Industrially prefabricated system components
- RST® installation plug connector system with protection rating up to IP69
- 7/5-pole compact distributors for single-phase power tap with dimming signal



ADVANTAGES

- Fast, easy, and safe installation
- High functional reliability through prevention of mismatching
- Simple adjustment of the installation to local conditions
- Subsequent extensions made easy thanks to pluggable components





FROM **CONCEPTION** TO INTERNATIONAL **ROLLOUT**.



IDEA

Future-oriented retail space planning calls for innovative solutions. You should consider an installation that is decentralized and pluggable.



DESIGNING THE CONCEPT

We will gladly produce a concept for you to present to building owners or decision-makers.

TECHNICAL SUPPORT: Phone +49 951 9324-996 · E-mail: building@wieland-electric.com

CONTACT YOUR LOCAL REPRESENTATIVE VIA OUR HEAD OFFICE:

Phone +49 951 9324-0 · E-mail: info@wieland-electric.com



WORKING OUT THE DETAILS

You are already in the pre-planning/design development phase: We will assist you with the implementation of your concrete plan through to the estimation of costs and, finally, the invitation to tender.



INVITING TENDERS AND TENDERING

The invitation to tender is on the market. The contractors will receive the tenders from us and will apply to execute the project.



ORDERING

Orders are placed directly through our Customer Service or our eShop: eshop.wieland-electric.com.



DELIVERY

Your items will be picked to your wishes and delivered on time to your company or to the place of use.



FURTHER SERVICE

Do you need support for your project? Our team in Bamberg and your local representative will be happy to help you. Please contact us.

STANDARDS (CPR) OVERVIEW

CONSTRUCTION PRODUCTS REGULATION

Since June 10, 2016 all cables permanently installed in a building have been covered by the CPR. Since July 1, 2017, all CPR cables have had to bear CE marking. German construction legislation does not currently specify which fire classes are to be used where. The minimum requirement is class E_{ca}.

CLASSIFICATION OF STANDARDS

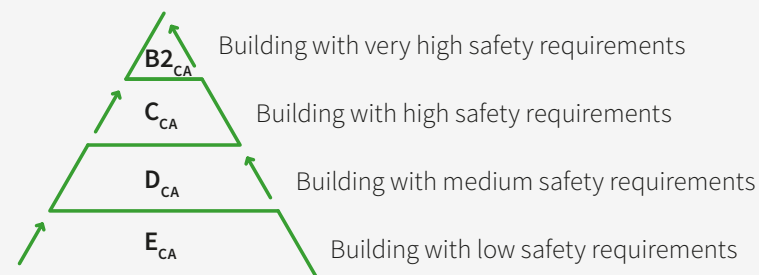

CPR – PROPOSAL OF THE GERMAN CABLE INDUSTRY | AS OF SEPTEMBER 2017

Description		Building	Escape route
Free-standing buildings	up to 7 m high, no more than 400 m ²	E _{ca}	
Buildings	up to 7 m high, no more than 400 m ²	E _{ca}	
Other buildings	up to 7 m high	E _{ca}	B2 _{ca} s1 d1 a1
Other buildings	up to 13 m high, up to 400 m ² per story	E _{ca}	B2 _{ca} s1 d1 a1
Other buildings, including underground buildings		C _{ca} s1 d2 a1	B2 _{ca} s1 d1 a1
Office/administration	rooms larger than 400 m ²	C _{ca} s1 d2 a1	B2 _{ca} s1 d1 a1
Restaurants/hotels	more than 40 guest places, more than 12 beds	C _{ca} s1 d2 a1	B2 _{ca} s1 d1 a1
Sales outlets	larger than 800 m ²	C _{ca} s1 d2 a1	B2 _{ca} s1 d1 a1

Sub-classification note: the lower the numerical value stated, the less damaging the behavior.



s – smoke



d – droplet formation



a – toxic gases

CASCADING OF MULTIPLE SOCKETS

Extendable fixed multiple sockets in the feed-through level (input and output GST18) can be cascaded subject to compliance with the installation instructions according to DIN VDE 0100, provided that these are linear extensions and not branches.

If these can be permanently installed (e.g. permanent connection to the product carrier or out of reach of laypersons), the installation can be extended to the maximum admissible cable length, provided that the total connection load of 3,500 watts and the maximum current of 16 A are not exceeded.

STANDARDS (DGUV V3) OVERVIEW

INSPECTION OF ELECTRICAL EQUIPMENT

Repeat inspection of electrical equipment – inspection intervals

As an example, the execution instructions in § 5(1)(2) of the accident prevention regulation provide guidelines for inspection intervals which apply in normal operating and environmental conditions:

Installation / equipment	Guideline and max. value for inspection interval	Type of inspection	Inspector
Electrical installations and fixed equipment	4 years	Good working order	Qualified electrician
Portable electrical equipment Extension and appliance connection cables with plug-in devices Connection cables with plug Movable cables with plug and fixed connection	Guideline: 6 months. With a failure rate of < 2 % the inspection interval can be extended to 2 years maximum	Good working order	Qualified electrician Also someone trained in electrical engineering if suitable measuring and testing devices are used.

Table: DGUV Regulation 3, Electrical installations and equipment (accident prevention regulation), execution instruction in § 5(1)(2).

Evaluation of different retail space installations

	Fixed installation + fixed electrical equipment	Fixed installation pluggable + fixed electrical equipment	Portable equipment
Operator	Qualified electrician	Person trained in electrical engineering	Layperson – following all the relevant instructions
Material	NYM cable, cable support systems, distributor boxes, only fixed luminaires	Wieland connector system, fixed or portable luminaires	Schuko® sockets, only portable luminaires
Compliant with VDE 0100	✓	✓	–
Compliant with IEC 61535	–	✓	–
Flexibility	– In terms of effort, any change corresponds to a new installation.	++ Easy to do and can be carried out by employees on-site.	++ Easy to do and can be carried out by employees on-site.
Safety	++	++	–
Costs	€€€	€€	€
Costs for rpt inspections	€€	€	€€€

OUR SERVICES AND SERVICING PACKAGES

With an extensive range of services and servicing packages, Wieland Electric is a highly capable partner, assisting its customers worldwide with the conception, planning, and implementation of smart electrical installations.

WE ARE WITH YOU ALL THE WAY

- From the first idea through to concept development.
- From the luminaire plan to the cabling concept.
- From the concept to the quantity survey and tendering material and through to the logistics to suit your needs.
- From the configuration and optimization of the system distributors to their industrial production and through to extensive documentation.

OUR SERVICES

- + CONCEPTION
- + PLANNING SUPPORT
- + IMPLEMENTATION
- + PROJECT PLANNING
- + OPTIMIZATION
- + REALIZATION
- + PRODUCTION
- + LOGISTICS

GESIS® PLAN

THE CONCEPTUAL DESIGN TOOL

Architects and electrical planners cannot perform their jobs without software planning tools, especially when reliable information regarding project scope, scheduling, and cost estimates is required.

Wieland Electric offers the gesis® PLAN software for planning pluggable electrical installations with gesis®. This conceptual planning tool uses CAD building data to generate installation drafts as well as parts and price lists.

gesis® PLAN also independently checks the current load of cables and detects errors. The planner can locate them immediately in the detailed 3D views.

Request gesis® PLAN free of charge:
gesisplan@wieland-electric.com

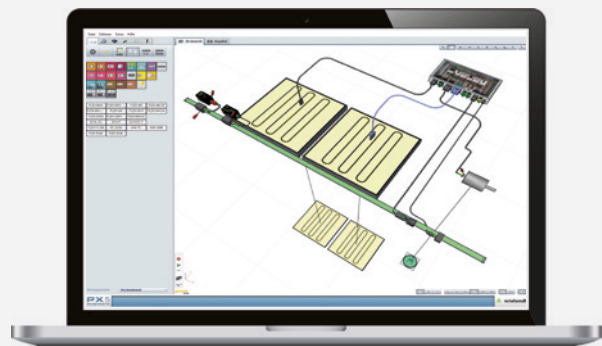

INFO TO GO

All brochures from Wieland Electric are available for download on our website.



<https://www.wieland-electric.com/en/support/downloads>

Interesting for you

GESIS® CATALOG

Pluggable
Electrical installation
Part No. 0670.1



WHITEPAPER INSTALLATION

Compliant electrical installation
for retail spaces
Part No. 0611.1



GESIS® NRG

Application examples for the electrical installation with flat cable
Part No. 0663.1



HELLO SHOP VIDEO

Directlink to the website for more information
<https://wie.li/webretailen>



Wieland on YouTube
See our solutions in motion

HELLO SHOP VIDEO

<https://youtu.be/j-zYB5sFP8M>

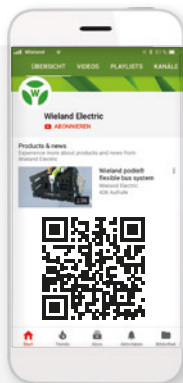

Technical consultation
Building Solutions



Fon: +49 951-9324-996

E-mail: building@wieland-electric.com

Worldwide: <https://wie.li/contactinternational>



ONLY ONE TAP AWAY

Our Wieland E-Shop

In our online store you will find all the information about our products, prices, and technical data.

Order easily and conveniently online, and check availability.

<https://eshop.wieland-electric.com>

Scan QR code – view products in the E-Shop.





wieland

HEADQUARTERS

Wieland Electric GmbH
Brennerstraße 10 – 14
96052 Bamberg · Germany

Phone +49 951 9324-0
Fax +49 951 9324-198
info@wieland-electric.com



0417.1 MC 02/26

Represented in over 70 countries worldwide:

www.wieland-electric.com